

IC-U20SR

PRODUCT GUIDE





PREFACE

This product guide is made to promote our new product, the IC-U20SR transceiver. The new product's outline and specifications are described in this document, and you will understand the target users, built-in functions, and sales points of this transceiver.

This product guide is for dealer sales staffs who are going to sell this transceiver for the first time and have already sold Icom analog mode products.

Icom hopes this product guide will help you to promote sales of the IC-U20SR transceiver.

Trademarks

Icom and the Icom logo are registered trademarks of Icom Incorporated (Japan) in Japan, the United States, the United Kingdom, Germany, France, Spain, Russia, Australia, New Zealand, and/or other countries.

USB TYPE-C is a trademark of USB Implementers Forum Inc.

All other trademarks are the properties of their respective holders.

© 2023 Icom Inc.

TABLE OF CONTENTS

PREFACE	2
SECTION 1	PRODUCT OUTLINE	4
	1-1 ABOUT THE IC-U20SR TRANSCEIVER.....	4
	1-2 SELLING POINTS	5
	1-3 PANEL DESCRIPTION.....	8
	1-4 FUNCTION DISPLAY DESCRIPTION.....	9
	1-5 DIMENSIONS.....	10
	1-6 TARGET USERS.....	11
SECTION 2	PRODUCT RANGE	12
SECTION 3	COMPARISON WITH OTHER ICOM MODELS	13
	3-1 FUNCTION COMPARISON	13
	3-2 SPECIFICATION COMPARISON	14
SECTION 4	COMPARISON TO COMPETITORS	15
	4-1 FUNCTION COMPARISON	15
	4-2 SPECIFICATION COMPARISON	16
SECTION 5	MAJOR FUNCTION INTRODUCTION	17
	5-1 EMERGENCY CALL	17
	5-2 CALL-RING FUNCTION	18
	5-3 SMART-RING FUNCTION.....	19
SECTION 6	OPTIONAL ACCESSORIES	20

SECTION 1 PRODUCT OUTLINE

1-1 ABOUT THE IC-U20SR TRANSCEIVER

The IC-U20SR transceiver is a PMR446 handheld transceiver. This model is designed assuming light mission users for short-range communication. This model has been designed to be rugged, even in this product class, and includes practical functions for the targeted market.

This transceiver is useful for various situations, for example, in restaurant, warehouse, or private use for short-range communications.

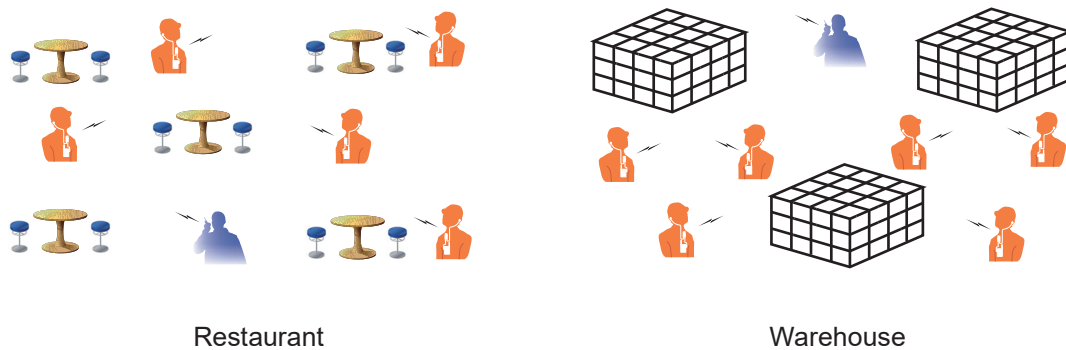

The fixed antenna on the IC-U20SR is designed at the optimum length for good communication performance and to be easy to carry.



1-2 SELLING POINTS

• SMALL SIZE AND LIGHT WEIGHT

The IC-U20SR is designed to be lighter in weight and smaller than the existing IC-F27SR and IC-F29SR2 PMR446 transceivers. Therefore, users can easily carry this transceiver in their pocket.

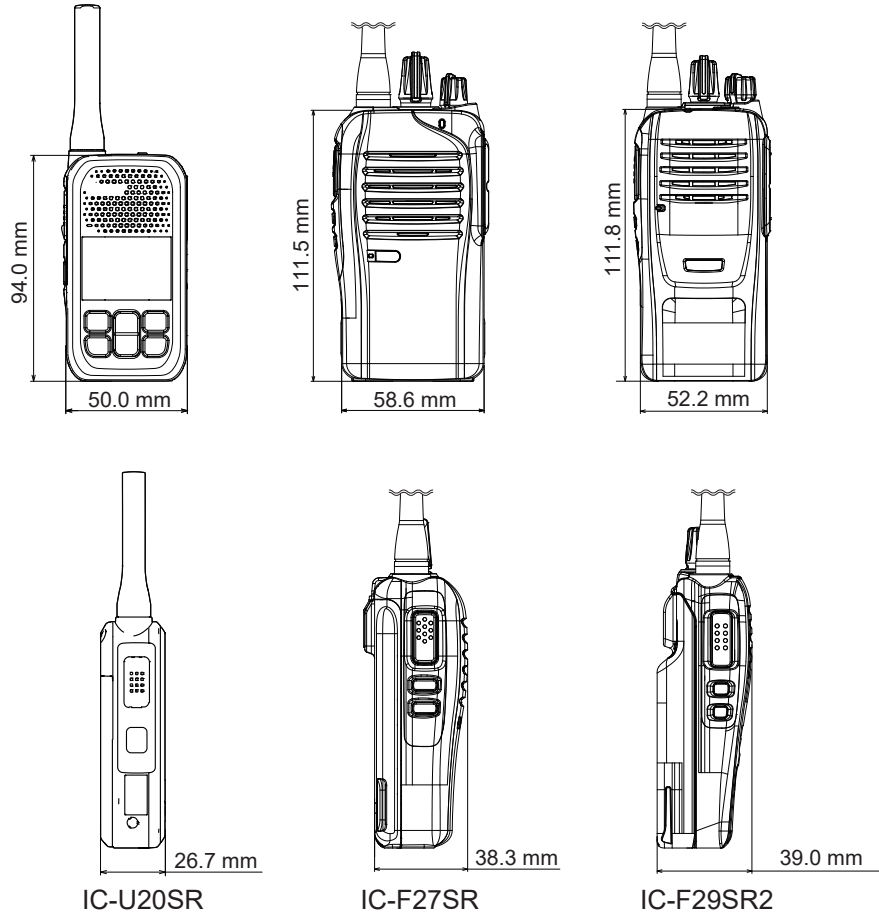

The IC-U20SR's comparisons of size volume and weight

Comparison model	IC-U20SR Size (H: 94.0 × W: 50.0 × D: 26.7 mm) Weight (157 g with BP-304A)	
	Size volume ratio	Weight ratio
IC-F27SR Size (H: 111.5 × W: 58.6 × D: 38.3 mm) Weight (340 g with BP-264)	50%	54%
IC-F29SR2 Size (H: 111.8 × W: 52.2 × D: 39.0 mm) Weight (270 g with BP-280)	45%	42%

• EASY OPERATION

The IC-U20SR has 6 keys on the front panel, and 1 each on the top and side panel. Only one function is assigned to each key, except [CH/SET]. So, users can easily to operate the IC-U20SR.

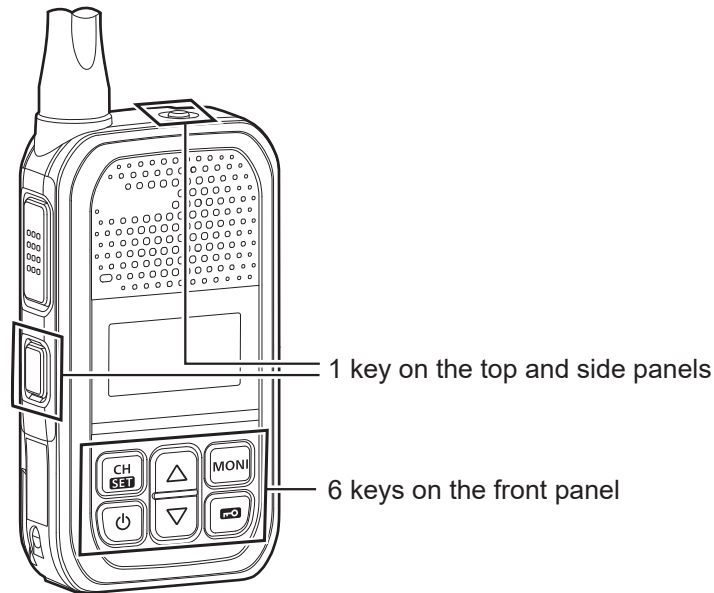

• IP54 CONSTRUCTION

The IC-U20SR is rated at the IP54 protection level. Therefore, this transceiver can be used outside.

• A USB PORT

Charging the installed battery pack is done with the supplied power adapter or other USB charger. The charging period may differ, depending on the charging current of the charging device.

NOTE: The USB port is only for battery charging, not for data communication.

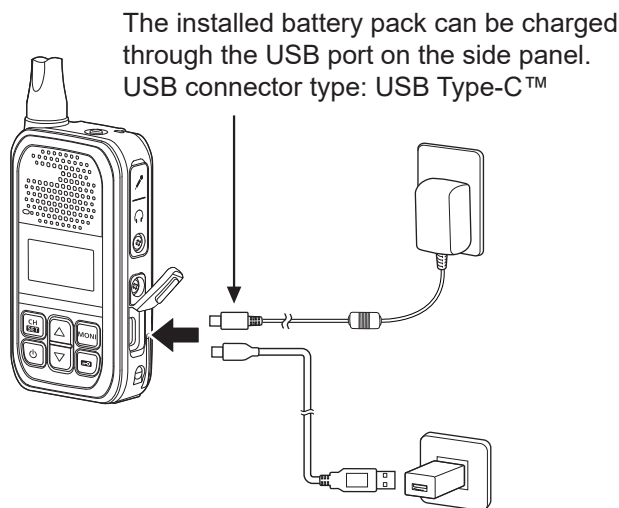

- The charging period is approximately 5.5 hours.

• PROGRAMMABLE KEYS

The IC-U20SR has 2 programmable keys on the top and side panels.

The Emergency function, Smart-Ring/Call-Ring function, Scan Start/Stop, or the Surveillance function can be assigned to these keys.

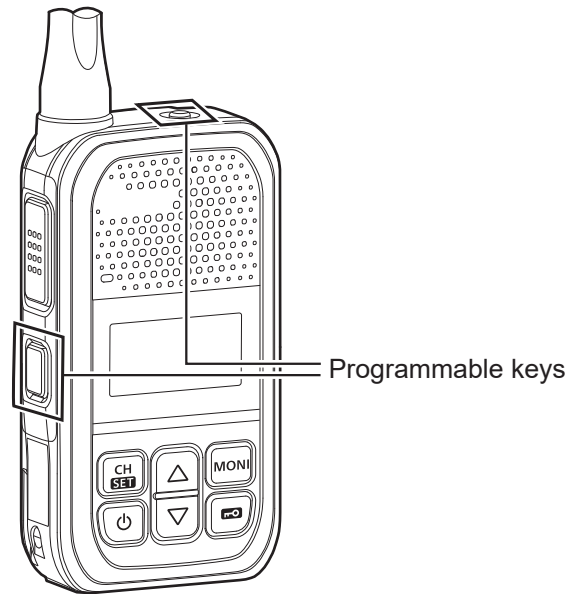

• HIGH AUDIO OUTPUT POWER

A 28 mm (1.1 inches) diameter speaker is installed.

The speaker provides 0.5 W high audio output, even in the small body.

Speaker sound pressure level: 83 dB \pm 3 dB (1 W/0.5 m at 1 kHz)

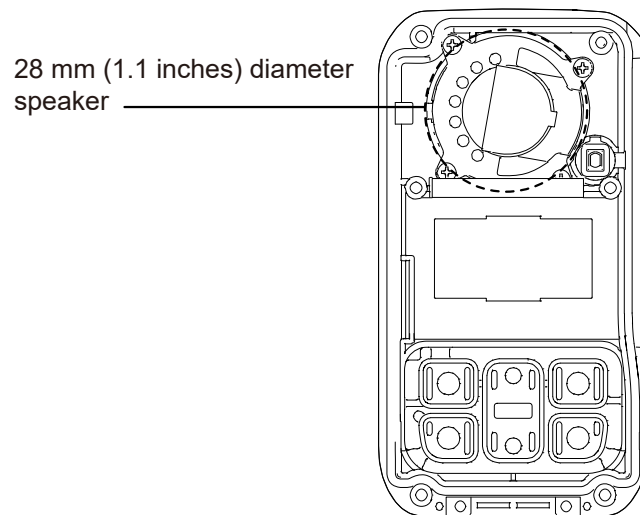

FRONT panel back view

1-3 PANEL DESCRIPTION

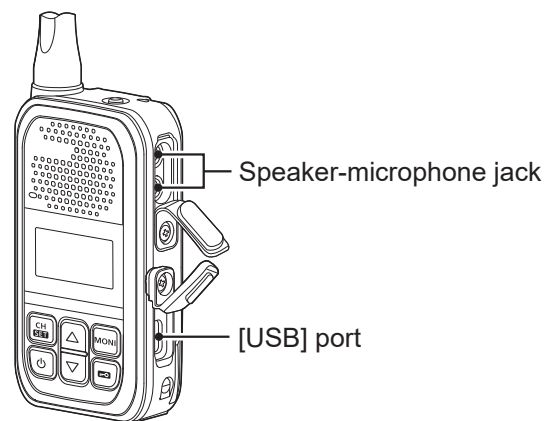
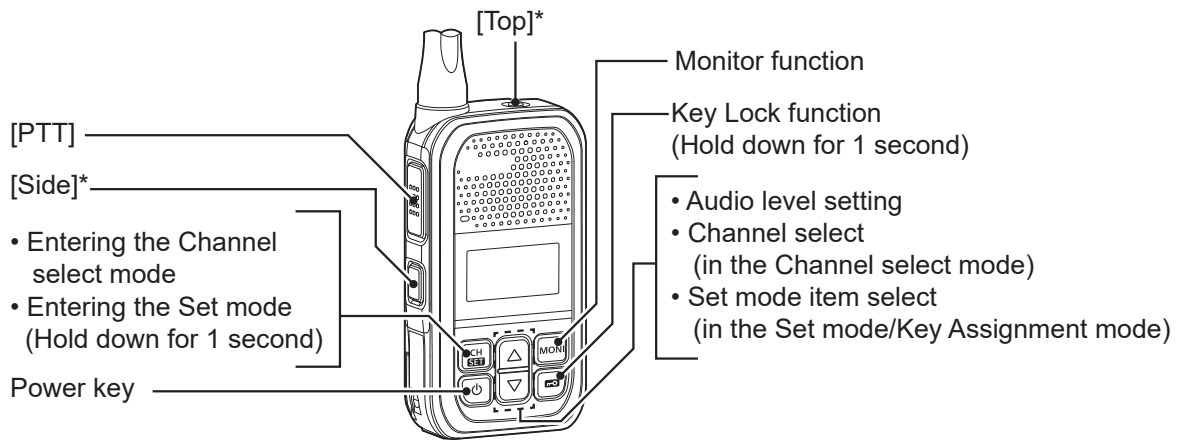

*[Top] and [Side] are programmable keys, and the function can be assigned using the optional CS-U20SR programming software or the transceiver operation as follows.

1. Turn OFF the transceiver.
2. While holding down [MON] and [Top], push [PWR] to enter the Key Assignment mode.
 - "KYST" is displayed.



3. Push [Side] or [Top] to select the key that operators want to assign the function to.
4. Push [▲] or [▼] to select a desired key function.
 - There are 5 options as follows.

1: Null, 2: Emergency, 3: Scan Start/Stop, 4: Surveillance, 5: S-Ring/C-Ring



When the surveillance function is assigned to [Side].



When the scan function is assigned to [Top].

5. Push [PWR] to turn OFF the transceiver and exit the Key Assignment mode.

1-4 FUNCTION DISPLAY DESCRIPTION

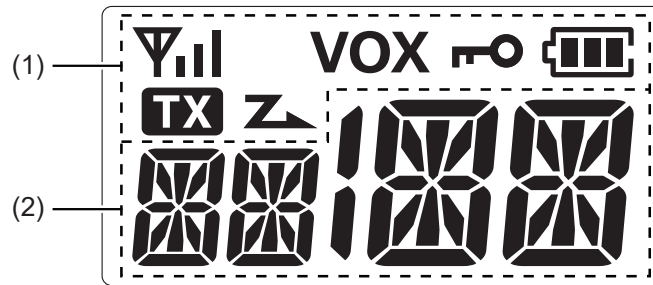

(1) Icon area

Displays the icons shown below.

Icon	Description
	<ul style="list-style-type: none"> Displayed while the channel is busy (receiving a signal). Blinks while the monitor function is turned ON.
	Displays the relative receive signal strength level.
VOX	Displayed when the VOX function is turned ON.
	Displayed when the Key Lock function is ON.

Icon	Description								
	<ul style="list-style-type: none"> Blinks while charging. Displays the remaining battery charge. <table border="1" style="width: 100%; text-align: center;"> <tr> <td></td> <td></td> <td></td> <td></td> </tr> <tr> <td>Full</td> <td>Mid</td> <td>Charging required</td> <td>Battery exhausted</td> </tr> </table>					Full	Mid	Charging required	Battery exhausted
Full	Mid	Charging required	Battery exhausted						
TX	Displayed while transmitting.								
	<ul style="list-style-type: none"> Displayed when the channel is selected as a Scan Target channel. Blinks while scanning. 								

(2) Alphanumeric readout

Displays channel number, audio level, or Set mode item.

1-5 DIMENSIONS

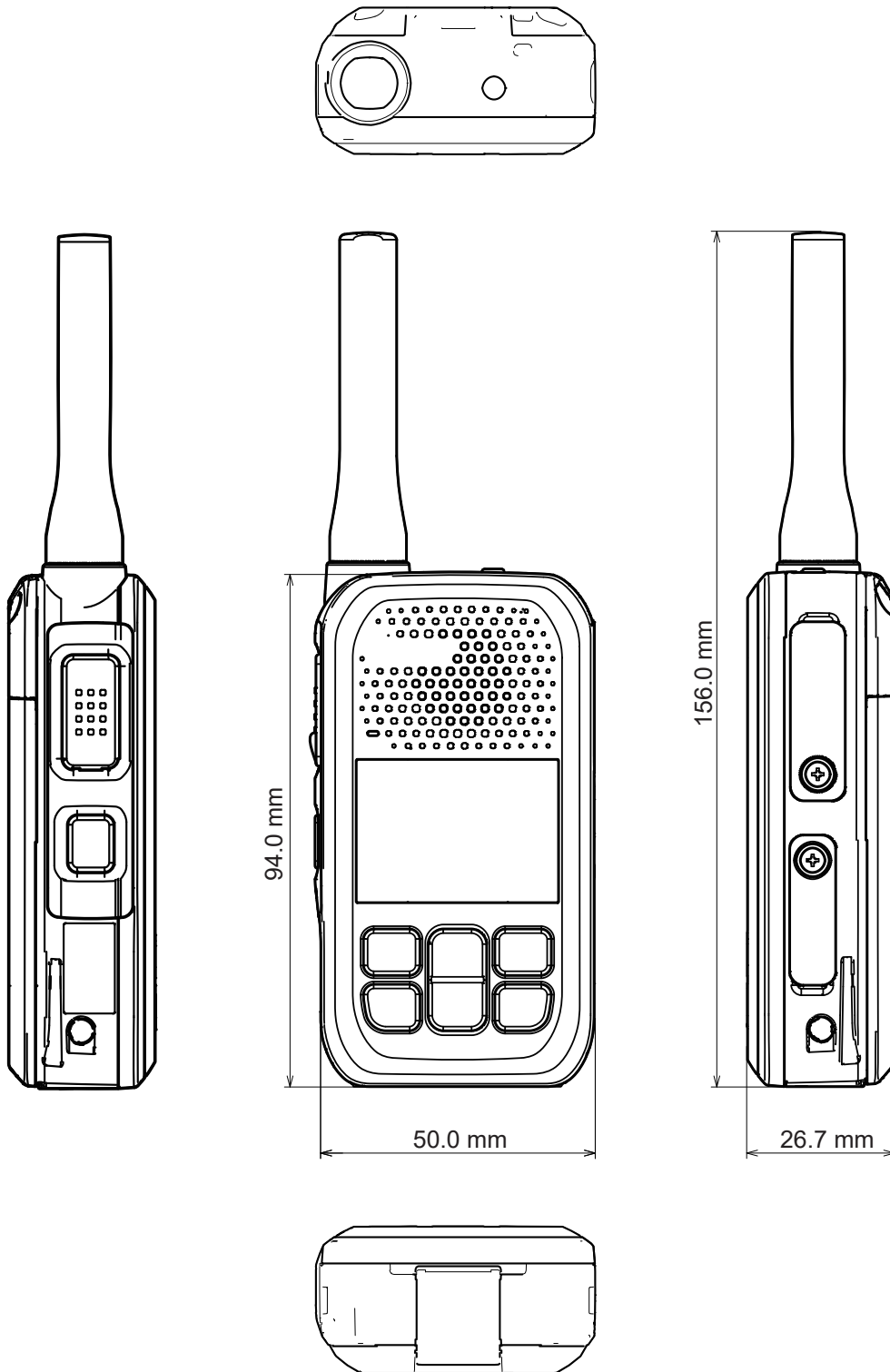

1-6 TARGET USERS



Supermarkets



Restaurants



Education Institutions



Event halls



Touring



Hiking

SECTION 2 PRODUCT RANGE

The IC-U20SR transceiver is positioned as the low-tier PMR446 hand-held transceiver, as shown on the positioning map below.

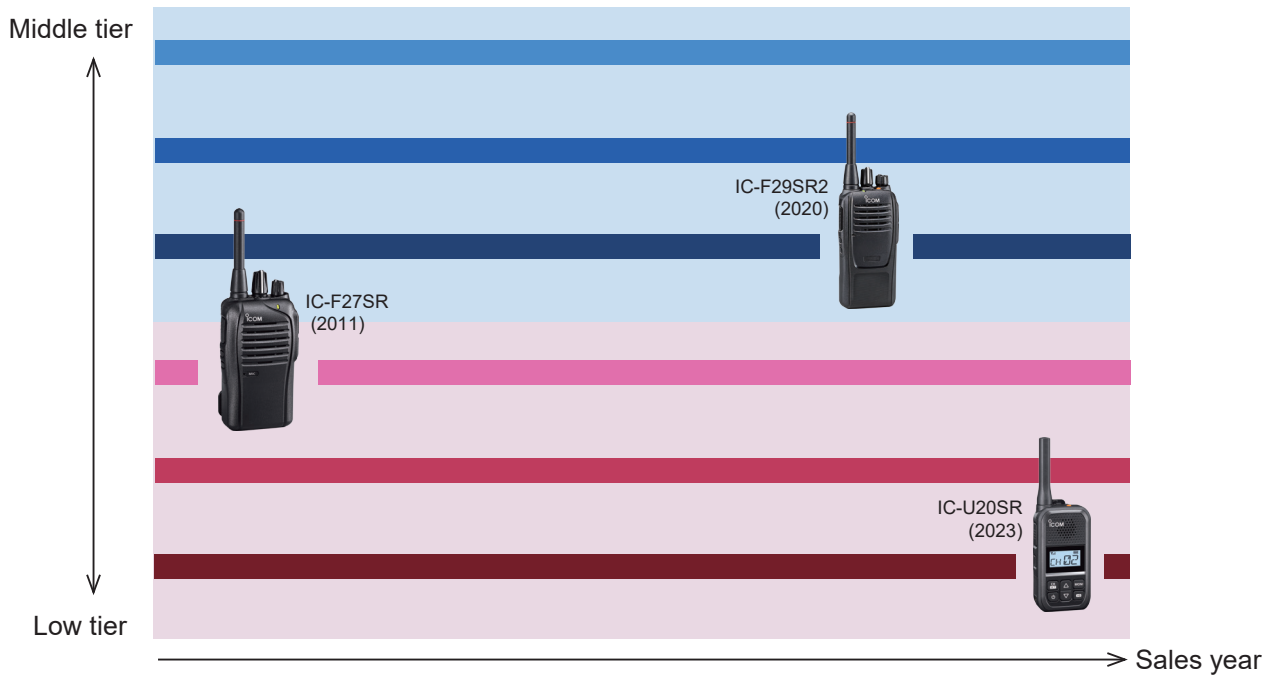

SECTION 3 COMPARISON WITH OTHER ICOM MODELS

3-1 FUNCTION COMPARISON

	IC-U20SR	IC-F27SR	IC-F29SR2
SIGNALING			
CTCSS	YES	YES	YES
DTCS	YES	YES	YES
EMERGENCY AND SECURITY FUNCTIONS			
Voice scrambler	NONE	NONE	YES
Emergency call	YES (TX only)*	NONE	NONE
Lone Worker function	YES (TX only)*	NONE	NONE
Surveillance function	YES	YES†	YES
CHANNEL ANNOUNCEMENT AND VOX FUNCTIONS			
Channel Announcement function	YES	NONE	YES
VOX function	YES	YES	YES
SMART-RING CALL/CALL-RING CALL			
Smart-Ring Call	YES	NONE	YES
Call-Ring Call	YES	NONE	YES
HARDWARE			
Number of programmable keys	2 keys	2 keys	3 keys
Compatible IP rating	IP54	IP54	IP67

*An MDC 1200 compatible transceiver is necessary for receiving.

†Programming is required.

3-2 SPECIFICATION COMPARISON

	IC-U20SR	IC-F27SR	IC-F29SR2
GENERAL			
Frequency coverage (MHz)	446.00625~446.19375	446.00625~446.19375	446.00625~446.19375
Number of channels	16	16	32
Power source voltage (Negative ground)	3.6 V DC nominal	7.2 V DC nominal	7.5 V DC nominal
Current drain (Approximate)	RX	0.33 A (Internal speaker)	0.5 A (Internal speaker)
	TX	1.0 A maximum	0.5 A
Dimensions (projections not included: H×W×D)	94.0 × 50.0 × 26.7 mm	111.5 × 58.6 × 38.3 mm (with the BP-264)	111.8 × 52.2 × 39.0 mm (with the BP-280)
Weight (Approximate)	157 g (with the BP-304A)	340 g (with the BP-264)	270 g (with the BP-280)
TRANSMITTER			
Rated output power	0.5 W ERP	0.5 W ERP	0.5 W ERP
Maximum permissible frequency deviation	±2.5 kHz	±2.5 kHz	±2.5 kHz
Frequency error	±500 Hz	±2.5 ppm	±2.5 ppm
Spurious emissions	≤1 GHz	0.25 μW maximum, 0.01 μW typical	0.25 μW
	>1 GHz	1.00 μW maximum, 0.01 μW typical	1.00 μW
Adjacent channel power	60 dB minimum, 63 dB typical	60 dB	60 dB
Audio harmonic distortion	5.0% maximum (at AF 1 kHz 40% Deviation)	1.0% typical (at AF 1 kHz 60% Deviation)	1.0% typical (at AF 1 kHz 60% Deviation)
Limiting characteristics of the modulator	70%~100% of maximum deviation	60%~100% of maximum deviation	60%~100% of maximum deviation
RECEIVER			
Sensitivity (20 dB SINAD)	-118 dBm typical	-117 dBm	-117 dBm
Audio power output	Internal SP	0.6 W typical at 5 % distortion into the 4 Ω load	1.5 W typical at 5 % distortion into the 8 Ω load
	External SP	0.15 W typical at 5% distortion into an 8 Ω load	• 0.4 W typical at 5 % distortion into an 8 Ω load • 1.5 W typical at 5 % distortion into the HM-222HLWP
Adjacent channel selectivity	55 dB minimum, 65 dB typical	81.29 dBμV/m	81.29 dBμV/m
Intermodulation	50 dB minimum, 54 dB typical	86.29 dBμV/m	86.29 dBμV/m
Hum and Noise (with a CCITT filter)	40 dB minimum, 48 dB typical	47 dB typical	47 dB typical
Squelch sensitivity (Threshold)	-123 dBm typical	-117 dBm typical	-121 dBm typical

Specifications: Measurements made in accordance with EN300 296 procedures.

SECTION 4 COMPARISON TO COMPETITORS

4-1 FUNCTION COMPARISON

	IC-U20SR	PKT-23E/T	XT420
SIGNALING			
CTCSS	YES	YES	YES
DTCS	YES	YES	YES
EMERGENCY AND SECURITY FUNCTIONS			
Emergency call	YES (TX only)*	NONE	NONE
Lone Worker function	YES (TX only)*	NONE	NONE
Surveillance function	YES	NONE	NONE
CHANNEL ANNOUNCEMENT AND VOX FUNCTIONS			
Channel Announcement function	YES	YES	YES
VOX function	YES	YES	YES
SCAN FUNCTION			
SCAN function	YES	YES	YES
HARDWARE			
Channel number display	YES	NONE	NONE
Number of programmable keys	2 keys	2 keys	2 keys
Compatible IP rating	IP54	IP54	IP55

*An MDC 1200 compatible transceiver is necessary for receiving.

4-2 SPECIFICATION COMPARISON

	IC-U20SR	PKT-23E/T	XT420
GENERAL			
Frequency coverage (MHz)	446.00625~446.19375	446.00625~446.19375	446.00625~446.19375
Number of channels	16	8	16
Operating temperature range	-30°C to +60°C	-10°C to +60°C	-30°C to +60°C
Dimensions (projections not included: H×W×D)	94.0 × 50.0 × 26.7 mm	85.0 × 46.0 × 21.0 mm	116.0 × 58.0 × 40.0 mm
Weight	157 g	110 g	244.0 g
TRANSMITTER			
Rated output power	0.5 W ERP	0.5 W ERP	0.5 W
Spurious emissions	≤1 GHz	0.25 μW maximum, 0.01 μW typical	0.25 μW
	>1 GHz	1.00 μW maximum, 0.01 μW typical	1.00 μW
Audio harmonic distortion (at AF 1 kHz 40% Deviation)	5.0% maximum	5.0% or less	2.0% or less
FM Hum and Noise (without a CCITT filter)	40 dB minimum, 56 dB typical	50 dB	-45 dB or less
RECEIVER			
Sensitivity	0.28 μV typical (20 dB SINAD)	0.45 μV (20 dB SINAD)	0.18 μV (12 dB SINAD)
Audio power output	0.6 W typical at 5 % distortion into the 4 Ω load	0.3 W at 5% distortion into the 4 Ω load	1.5 W with 5% distortion into the 8 Ω load
Adjacent channel selectivity	55 dB minimum, 65 dB typical	60 dB	70 dB
Intermodulation	50 dB minimum, 54 dB typical	60 dB	70 dB

Specifications: Measurements made in accordance with EN300 296 procedures.

SECTION 5 MAJOR FUNCTION INTRODUCTION

The major functions of the IC-U20SR transceiver based on the main firmware Rev. 1.0 are described as follows.

5-1 EMERGENCY CALL

The IC-U20SR can make an Emergency call by the following two methods.

• Using [Emergency]

Hold down [Emergency] on the top panel for 2 seconds* (default setting), and the IC-U20SR enters the Emergency mode.

When the Reminder Timer* (default setting is 0 seconds) time has passed, the IC-U20SR makes an Emergency call.

Hold down [Emergency] to make an Emergency call.

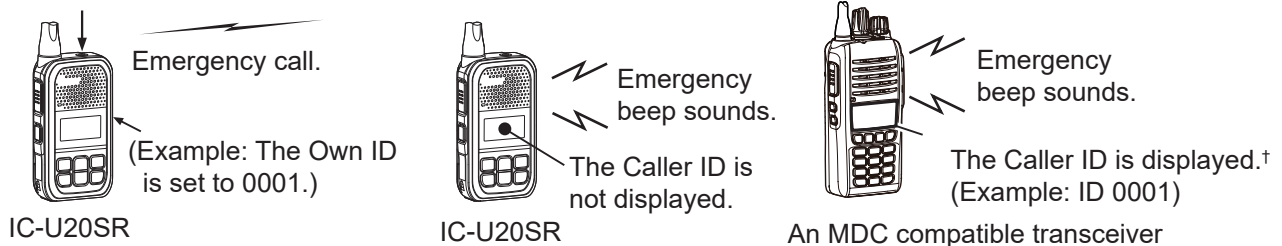

• Lone Worker

When no key operation is performed for the ON Timer preset time (default setting: 60 minutes*), the IC-U20SR enters the Emergency mode, and the countdown starts. When the countdown time set in the Reminder Timer (default setting: 60 seconds*) has passed, the IC-U20SR makes an Emergency call.

No key operation is performed.

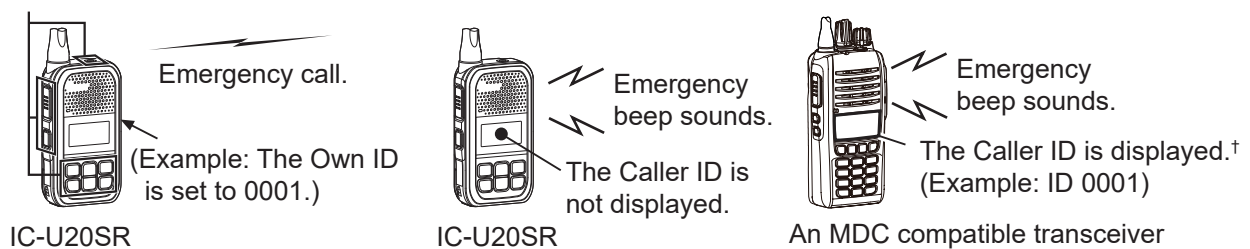

The MDC 1200 signal is used for the IC-U20SR Emergency call. However, the IC-U20SR does not have an MDC 1200 decoder, so another transceiver with an MDC 1200 decoder, such as the IC-F2000T, is necessary to know who is in an emergency state.

*The setting period can be changed using the CS-U20SR.

†The Caller ID can only be displayed on an MDC 1200 compatible transceiver.

5-2 CALL-RING FUNCTION

The Call-Ring function calls the same group's transceiver operators by sounding the preset ringer.

This function is useful when the Caller operator wants to notice to start communication for the same group members, or when a voice call is difficult during events such as concerts.

It is recommended to use a different ringtone for each group. Users can identify the group by the ringtone. The ringer can be set in the Call-Ring Pattern item in the User Set mode.

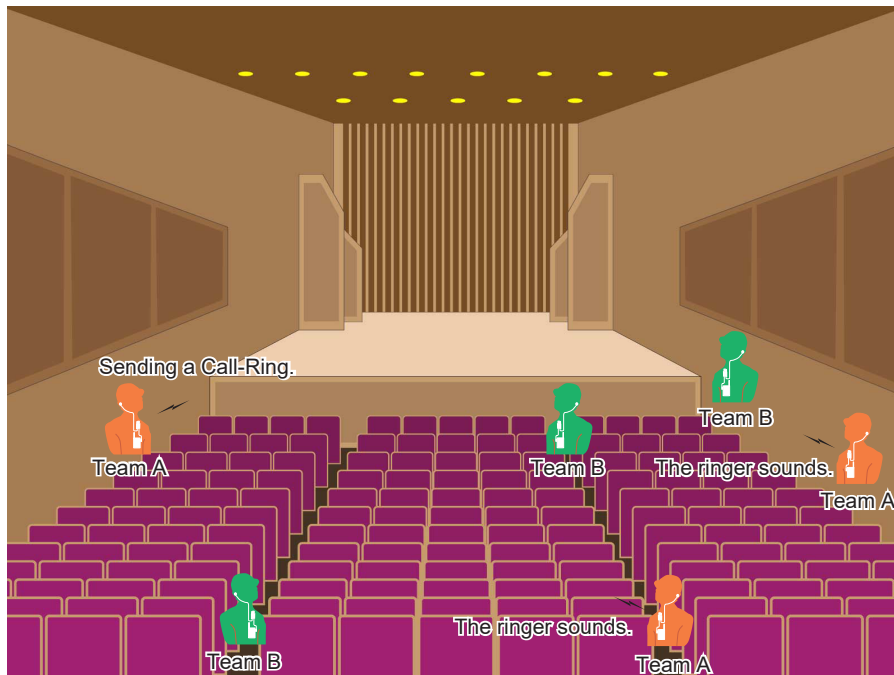

Call-Ring Operation

Keep holding down **[S-Ring/C-Ring]** for at least 1 second to send the preset ringer.

- The same ringer sounds from your group member's speaker.

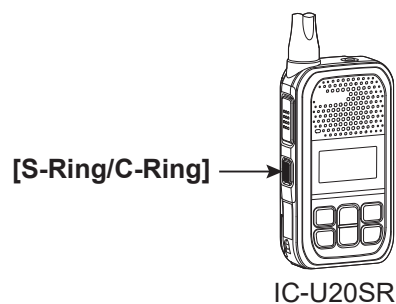

NOTE: To use this function, the operating channel and CTCSS tone or DTCS code must be the same on all of the operator group's transceivers.

5-3 SMART-RING FUNCTION

The Smart-Ring function notifies whether some transceivers are within range or out of range. Target transceivers that receive a Smart-Ring call sound the Ringer melody. The Target transceivers automatically send an answer back signal to the Caller transceiver.

This function is helpful to know whether the target transceivers are in an operable area/state before making a call.

The Target transceivers are in an operable area/state when an answer back signal is received.

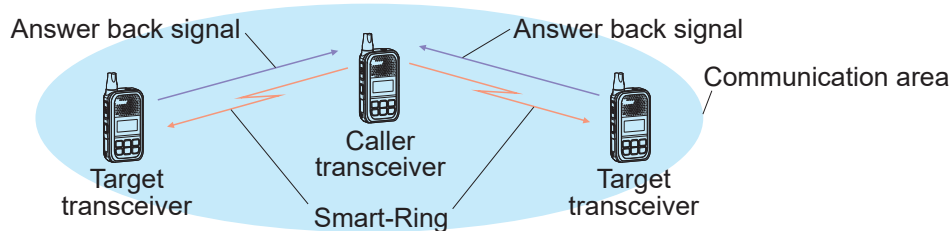

When no answer back signal is received, the transceivers are out-of-range or inoperable.

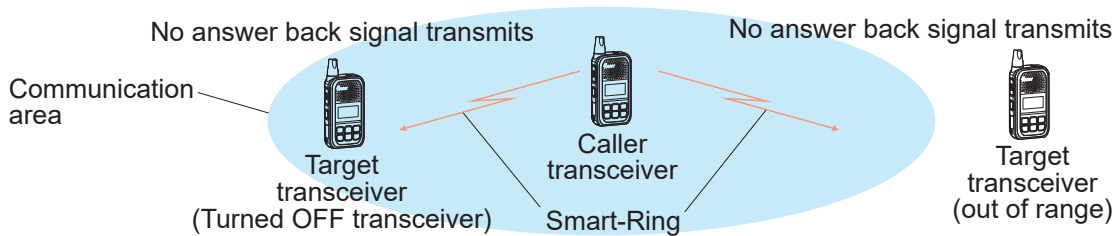

Smart-Ring Operation

Push **[S-Ring/C-Ring]** to make a Smart-Ring call.

- The **TX** icon is displayed.
- When an answer back signal is received, the Caller transceiver sounds the Ringer melody and displays "SR OK."

Push any key to stop the Ringer melody.

When the Target transceivers receive the Smart-Ring call, the transceivers also sound the Ringer melody and display "SR OK."

- When no answer back signal is received, the Caller transceiver sounds three short failure beeps and displays "SR NG."

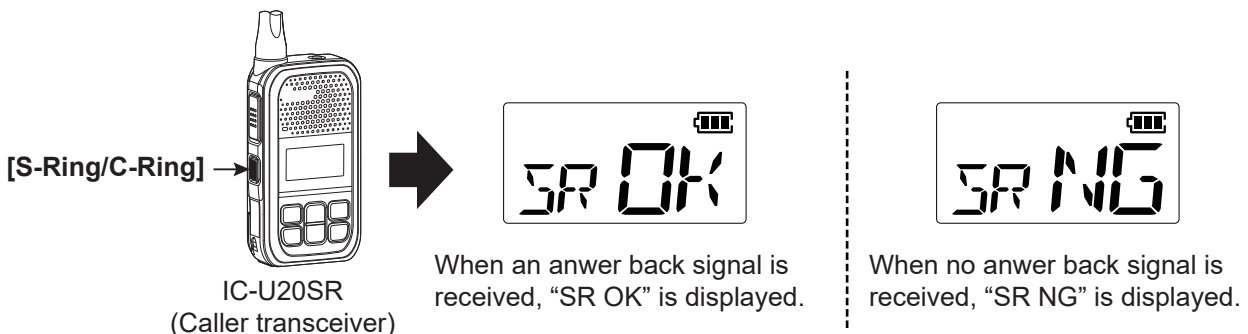

NOTE:

- To use this function, the operating channel and CTCSS tone must be the same on all of the operator group's transceivers.
- This function can be operated for channels which CTCSS tone is set for.

SECTION 6 OPTIONAL ACCESSORIES

Current (as of July 2023) optional accessories available for the IC-U20SR transceiver are shown below.

CHARGER

- **BC-262**

(Same as the supplied charger)



Specification

Input voltage	5.0 V±0.25 V DC
Output voltage	4.9 V±0.25 V DC (500 mA load)
Operating temperature range	0°C~+45°C
Dimensions	75 (W) × 38 (H) × 50 (D) mm (Projections not included)
Weight	Approximately 46 g
USB connector type	USB Type-C™

BATTERY PACK

- **BP-304A** (3.6 V DC, Minimum: 2270 mAh, Typical: 2350 mAh)
(Same as the supplied battery pack)



BELT CLIP

- **MB-127**



MICROPHONES

• **HM-183LS**

Speaker-microphone
 (Water and dust proof: IP67,
 Cable length: Approximately 0.52 m*)



• **HM-186LS**

Speaker-microphone
 (An ear phone connectable microphone)
 (Water and dust proof: IP54,
 Cable length: Approximately 0.52 m*)



• **HM-166LS**

Tie-pin microphone with earphone
 (Cable length: Approximately 1.00 m,
 Ear phone cable length: Approximately 0.45 m)



• **HM-153LS**

Tie-pin microphone with earphone
 (Cable length: Approximately 1.00 m,
 Ear phone cable length: Approximately 0.5 m)



*When curled.

HEADSETS AND ADAPTER CABLES

• **HS-94**

Earhook type with boom microphone
 (Cable length: Approximately 0.8 m,
 Boom length: Approximately 0.1 m)



• **HS-95**

Behind head type
 (Cable length: Approximately 1.00 m,
 Boom length: Approximately 0.12 m)



• **HS-97**

Throat Microphone type
 (Cable length: Approximately 0.8 m,
 Microphone cable length: Approximately 0.23 m)



• **OPC-2006LS**

Adapter cable for HS-94, HS-95, and HS-97
 (Cable length: Approximately 0.13 m)



• **OPC-2328**

Adapter cable with the PTT switch for HS-94,
 HS-95, and HS-97
 (Cable length for transceiver:
 Approximately 0.77 m,
 Cable length for headset:
 Approximately 0.14 m)



Revision record

Version	Month/Year	The revised contents
Version 1.0	July 2023	First issue.

How the World Communicates

Icom Inc.

1-1-32 Kamiminami, Hirano-ku, Osaka 547-0003, Japan <https://www.icomjapan.com/>